

# CHARGING and DISCHARGING SET

Doldurma ve boşaltma setleri



Complete series of charging unit, charging adapters and discharging devices, for both self-contained gas springs and control panels

Hem bağımsız gazlı amortisörler hem de kontrol panelleri için eksiksiz şarj ünitesi, şarj adaptörleri vedeşarj cihazları serisi

Model  
Model

COMPL

## CHARGING UNIT

Doldurma ünitesi



This device allows to charge Bordignon self-contained gas springs and control panels with nitrogen gas.

Bu cihaz, Bordignon bağımsız gazlı amortisörlerin ve kontrol panellerinin nitrojen gazı ile şarj edilmesini sağlar.

Specifications / Özellikler

Model  
Model

CUC01

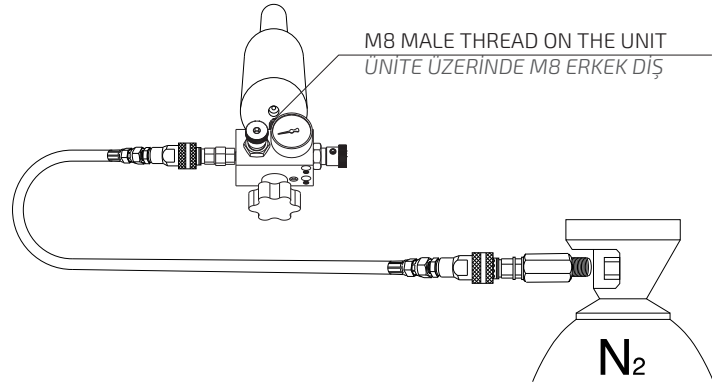

Model (optional)  
Model (opsiyonel)

ATAP01

Extension hose (length: 2 metres) for an easier charging of control panels  
Kontrol panellerinin daha kolay şarj edilmesi için uzatma hortumu (uzunluk: 2 metre)

Standard system (direct connection of charging unit CUC01 to control panel)

Standart sistem (şarj ünitesi CUC01'in kontrol paneline doğrudan bağlantısı)

(AN-1/4 charging adapter for control panels)  
(Kontrol panelleri için AN-1/4 şarj adaptörü)

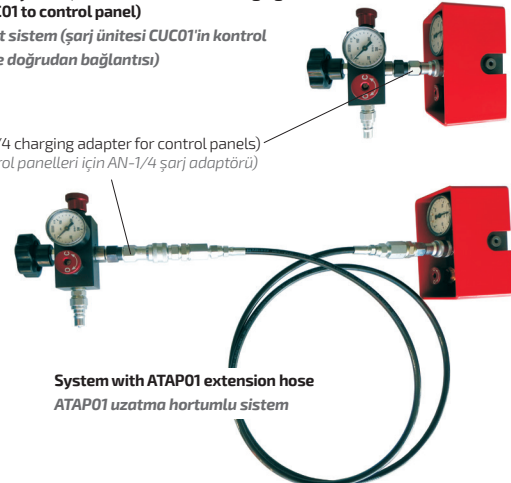

# CHARGING ADAPTERS





AUTOMOTIVE LINE

## Doldurma adaptörleri



Adapters for the nitrogen gas springs charging unit (only for gas springs with charging hole different from M8). Gas springs with charging hole M8 (not listed in table below) must be charged with CUC01 unit with no adapter.

Nitrojen gazlı amortisör şarj ünitesi için adaptörler (sadece M8'den farklı şarj deliği olan gazlı amortisörler için). Doldurma deliği M8 olan (aşağıdaki tabloda listelenmeyen) gazlı amortisörler, adaptörsüz CUC01 ünitesi ile şarj edilmelidir.

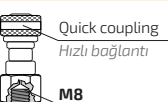
	Model Model	For gas spring models... Gazlı yay modelleri için...	Control panels Kontrol panelleri
 M4 M8	AN-M4	EGS16, TGS700	-
 M5 M8	AN-M5	EGS24	-
 M6 M8	AN-M6	AGS170-AGS320, TGS400, VGS (bütün modeller), VV170, VV320-63/63H, VV320-80, VV500, VV565	-
 M6 M8	AN-M6/2	AGS350-AGS2400, IGS150-IGS250, VV2385	-
 G1/8 M8	AN-1/8	AGS4200-AGS20000, IGS500-IGS10000, LGS500, VV750, VV2945	-
 Quick coupling Hızlı bağlantı M8	AN-1/4	-	All models Bütün modeller









# DISCHARGING DEVICES

## Boşaltma cihazları



Devices for discharging the nitrogen gas springs.

Gazlı yay gaz boşaltma ekipmanları.

	Model Model	For gas spring models... Gazlı yay modelleri için...	Control panels Kontrol panelleri
 M4	ADS-M4/2	TGS700	-
 M4	ADS-M4/3	EGS16	-
 M5	ADS-M5/2	EGS24	-
 M6	ADS-M6	TGS400	-
 M6	ADS-M6/2	AGS170-AGS320	-
 M6	ADS-M6/3	AGS350-AGS20000, IGS (bütün modeller), LGS500, VV750, VV2385, VV2945	-
 M6	ADS-M6/4	VGS (todos os modelos), VV170, VV320-63/63H, VV320-80, VV500, VV565	-
 M8	ADS-M8	TGS1000-TGS12000	-